

COTTOD'ESTE  
EXCLUSIVE SURFACES

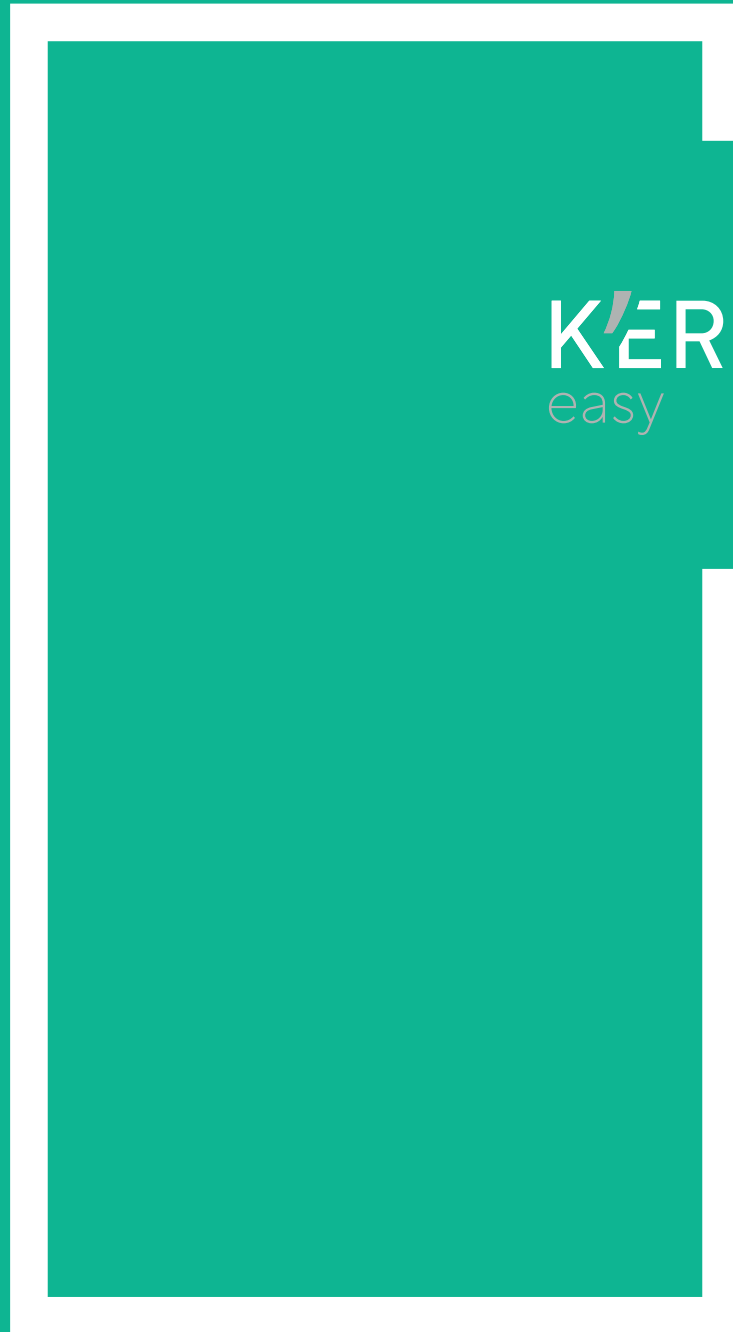

KERLITE  
easy



TECHNICAL INSTALLATION MANUAL

# What the system is comprised of

## 1 SILENT soundproofing mat

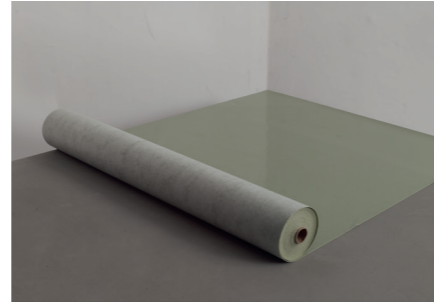

## 2 K'ERLITE 6plus K'ERLITE 5plus

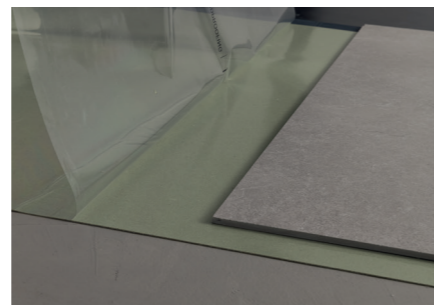

## 3 FILLER finishing sealant



### Kerlite Easy offers two exclusive solutions for grout line finishes

#### FILLER FAST



Easy and quick to apply for a pedestrian floor in just a few hours. Its matte finish makes it perfect for modern surfaces.

#### FILLER ARDEX SC MATT



Easy and quick to apply for a pedestrian floor in just a few hours. The remarkable textured look makes it ideal for high-end surfaces.

For further information about the individual components please consult the relative technical data sheets

# 1

Kerlite - laminated porcelain stoneware - is characterized by the extraordinary dimensions of the slabs, which reach the sizes 100x300 cm and 120x278 cm, and by the reduced thickness, from 3.5 mm to 6.5 mm. The final product is light, resistant, versatile and easy to use. Kerlite is a truly universal ceramic surface which is the fruit of Panariagroup's unrelenting research activity into beauty and technical excellence. It is ideal for numerous applications in the world of architecture and design and it is suitable for covering not only floors and walls, but also furniture, accessories, kitchens and countertops, ventilated façades and walls, tunnels and large public works.

For further information see Kerlite Technical Manual.

### A complete range of over 140 articles

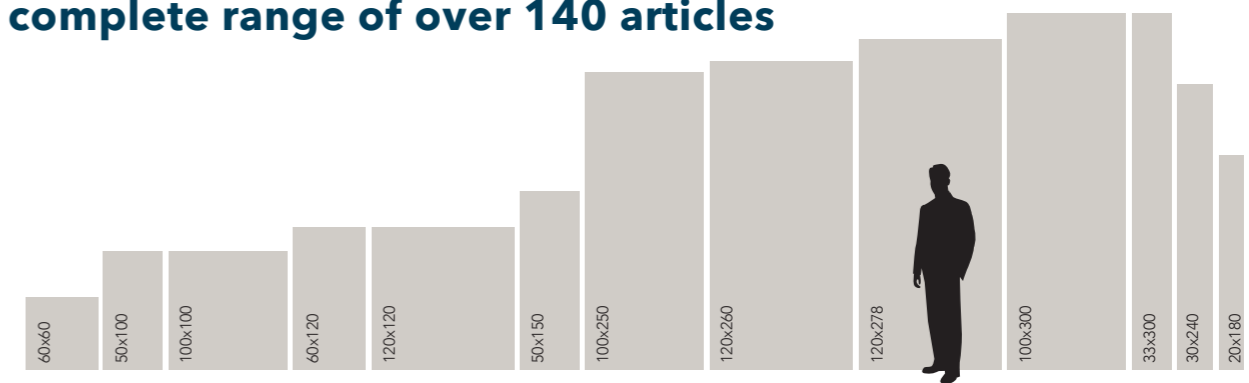

Ultrathin and ultras resistant

Reinforced with fibreglass mesh on the reverse side

5plus  
5,5 mm  
sizes up to  
100x300 cm

6plus  
6,5 mm  
sizes up to  
120x278 cm

Kerlite Easy can be used only with 5plus and 6plus slabs in all available sizes except the 20x120 cm size. Products with special finishes can have limitations depending on their area of application. Refer to specific collection catalogues.

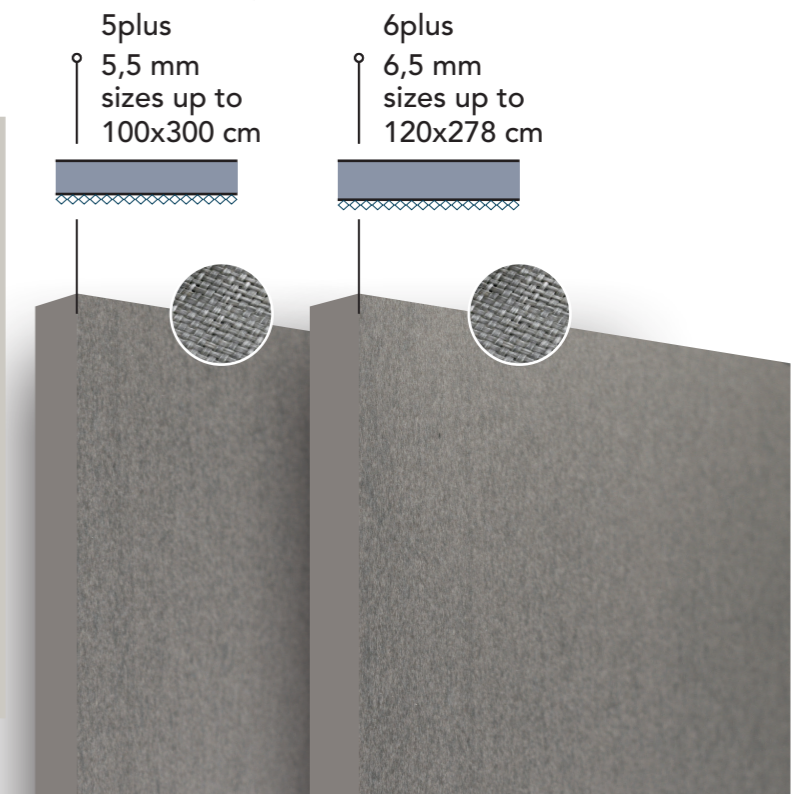

## 2

SILENT  
soundproofing mat

## What the system is comprised of

SILENT is a plant based polyurethane decoupling mat with inert fillers. It has outstanding thermal conductive properties and, when used with Kerlite, does an excellent job of reducing footfall noise as well.

It is a product without "memory": once laid it immediately moulds to the shape of the support onto which it has been installed and does not maintain the wavy shape created by having been packaged in rolls. This trait makes it possible to significantly reduce installation times.

SILENT ensures a substantial degree of surface grip, a characteristic that is fundamental to ensuring that Kerlite is laid properly. In fact, once a Kerlite slab has been laid, it adheres very well to the mat while still allowing for subsequent adjustments.

The superficial part of the mat is protected by a transparent plastic film. This has two benefits:

- 1) It preserves the characteristics of the mat over time;
- 2) It makes it possible to lay the mat and to take off the protective film a little at a time as one proceeds with installation, rather than to have to move around a mat that gets stuck to the soles of one's shoes.



## Primary Benefits

### ACOUSTIC BENEFITS

The Kerlite Easy system is soundproofed thanks to the combined action of the SILENT mat and Kerlite. The system's soundproofing is equal to 17dB, which means that footfall noise transmitted to the lower floor is approximately 16 times less than that of a traditional ceramic floor laid using adhesives.

### PRESERVES THE EXISTING FLOOR

The Kerlite Easy system is perfect for installation on heated/cooled floors.

### ALLOWS FOR INSTALLATION WITHOUT JOINTS

Thanks to the use of the SILENT mat, the Kerlite Easy system can be installed without expansion joints even on critical surfaces like: mixed subfloors, under-floor heating systems, old ceramic subfloors, floors at constant risk of cracking, wooden supports, etc.

### INSTALLATION ON HEATED/COOLED FLOORS

The Kerlite Easy system is perfect for installation on heated/cooled floors. That's because Kerlite and SILENT are two materials with excellent thermal-conductive characteristics which, when combined with their reduced thickness, make EASY the best solution for cladding a radiant floor.

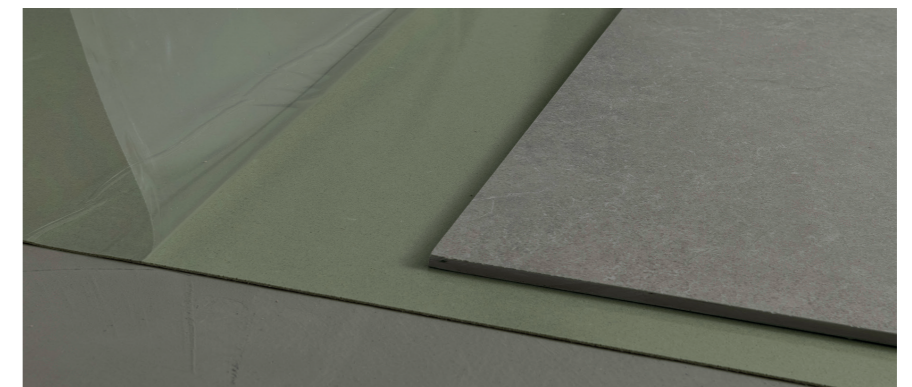

### CAUTION

Before positioning the slabs, the mat's transparent protective film must be removed.

## 3

## FILLER

FAST  
finishing sealant

## FILLER

ARDEX SC MATT  
finishing sealant

## What the system is comprised of

FILLER is a highly elastic and mould-resistant silicone sealer, suitable for movements up to 20%.

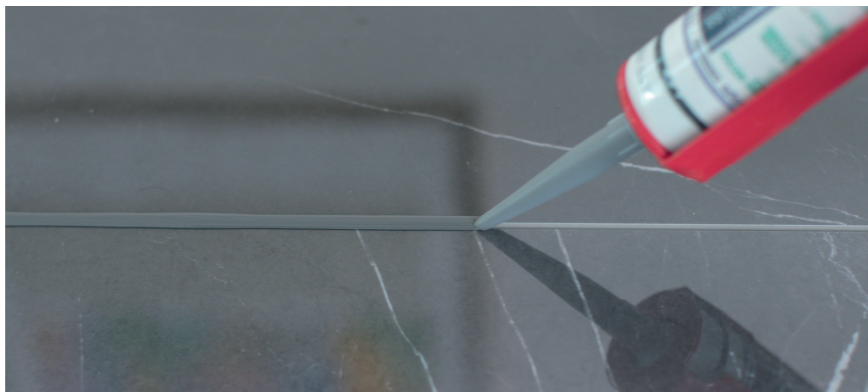

FILLER, a single-component silicone sealer, is easy to work with and can be perfectly finished.

Thanks to its remarkable characteristics, it provides the following properties:

- outstanding durability; the seal remains unaltered even after being exposed for many years to adverse weather conditions, industrial atmospheres, sudden changes in temperature, and immersion in water;
- high elasticity;
- excellent adhesive performance;
- mould resistant;
- impermeable to water and permeable to water vapour;
- resistant to chemical agents;
- flexible all the way down to -40°C and resistant to temperatures greater than +180°C;
- easy to work with;
- compliant with numerous international regulations;
- compliant with EN 15651-1, EN 15651-2, and EN 15651-3 and bears the CE seal.

### Primary Benefits

#### STABLE

The fiberglass mesh on the rear side of the laminated porcelain stoneware slabs combined with the use of the SILENT mat and FILLER FAST sealant ensure the utmost durability and stability to the floor.

#### WATERPROOF

The combined use of laminated porcelain stoneware and FILLER FAST sealant guarantees that the floor is entirely waterproof.

#### MORE BEAUTIFUL

The combined use of laminated porcelain stoneware, SILENT, and FILLER FAST makes it possible to install a floor without expansion joints, which makes it more beautiful.

# How to use the Kerlite Easy system efficiently

The installation of Kerlite with the KERLITE EASY system includes all the phases starting from the design that lead to the final result. These activities are essentially the following:

## 1 PROJECT AND SUBSTRATE ANALYSIS AND PLANNING

Starting from the project design, the installer prepares and agrees with the client/project supervisor a schedule for the various installation phases. This schedule must take into account the time requirements of the various phases, as well as the timing for the curing required by certain materials (e.g. adhesives and levelling products).

It is the installer's responsibility to formally point out to the client any inconsistencies between the design and the actual installation.

## 2 MONITORING OF ENVIRONMENTAL CONDITIONS

The working environment temperature must be between 5°C and 50°C to guarantee the proper application of the FILLER sealant.

## 3 HANDLING, STORAGE AND CHECKING MATERIALS

On arrival at the construction site, the materials must be checked and stored. The installer must promptly and formally highlight any obvious defects. Defective materials must not be installed unless a formal written order has been received from the customer.

## 4 LAYING OF THE MAT, INSTALLATION AND CUTTING OF KERLITE

For the laying of the mat and the cutting of Kerlite please refer to the dedicated technical sheet. For more info about Kerlite application please refer to the Kerlite technical manual.

## 5 PREPARATION AND APPLICATION OF GROUTING JOINTS AND EXPANSION JOINTS

For preparation and application of grouting and expansion joints refer to the dedicated technical sheet.

## 6 POST-INSTALLATION CLEANING AND PROTECTION

It is the installer's responsibility to deliver the tiling clean in its entirety. After cleaning, the installer must also take care of protecting the tiling (with suitable systems) until its delivery to the client.

## 7 TESTING

The testing of tiling consists in the process of verifying the quality of the tiling itself. Testing is the responsibility of the client, and must be carried out before it is ready for use, in the presence of the designer and the installer. The client is entitled to draw up an acceptance report at the end of the testing period.

## 8 MAINTENANCE

The maintenance of the tiling to be carried out on laminated porcelain stoneware only includes cleaning operations. For cleaning methods refer to Kerlite technical manual.

For further information about the individual components please consult the technical data sheets.



# 8

**STEPS TO FOLLOW  
TO ENSURE OPTIMAL RESULTS**

# Project Analysis: Suggestions for creating a laying plan.

In order for the KERLITE EASY system to function properly, and to obtain the best aesthetic result, we recommend conducting a survey of the space before starting work and subsequently creating a laying plan which will be executed.

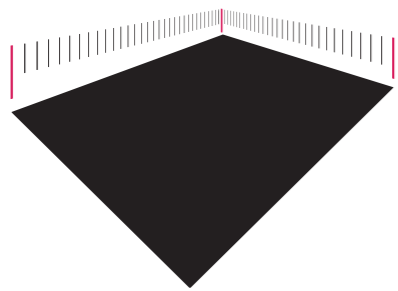

1 Measure the project room.

2 Note the size of the slabs which will be used

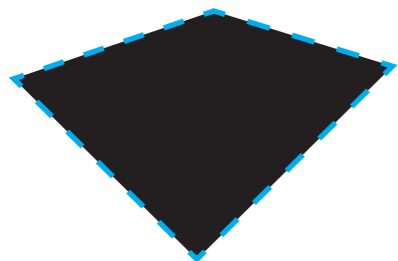

3 Consider an outer joint of approximately 5/8 mm

4 Take into account the size of the grout lines when calculating the surface required, remembering that these will be at least 2 mm thick using FILLER.

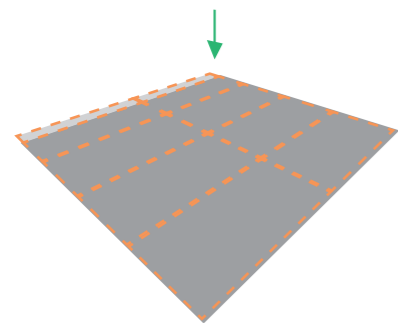
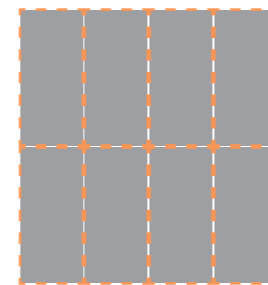

5 Verify whether or not it will be necessary to cut the slabs.

If the slab must be cut to less than half of its original size, trim the edges.

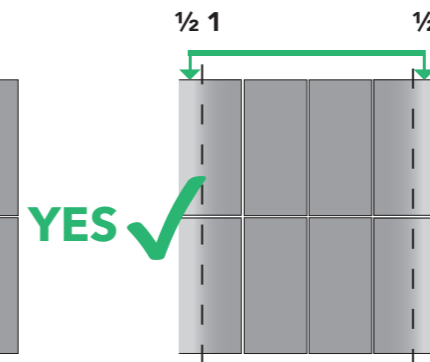
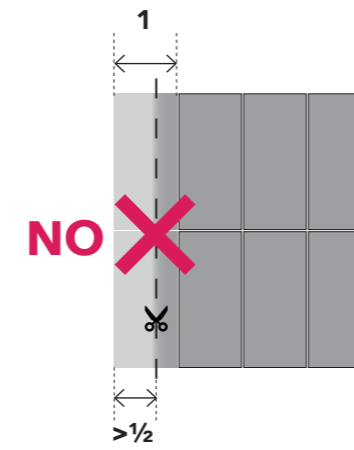
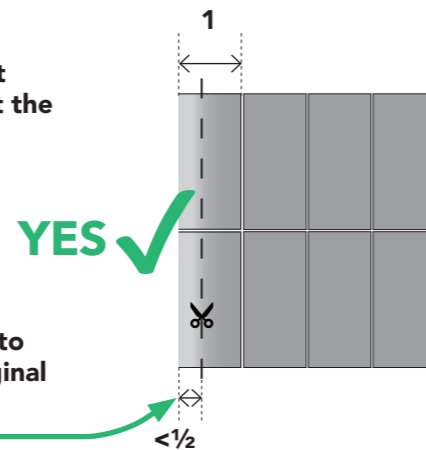

However, if the slab must be cut to less than half of its original size, then proceed by splitting the cut between the two sides of the space.



**FOR AN OUTSTANDING AESTHETIC RESULT, FINISH THE FLOORING WITH SLABS CUT TO NO MORE THAN 50% OF THEIR ORIGINAL SIZE ON THE SHORT SIDE.**

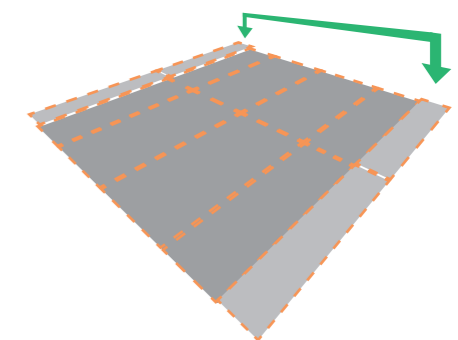

## Analysis of Substrate

Kerlite cladding with the KERLITE EASY system can be installed on any type of floor substrate as long as its design and construction has taken into account the necessary project requirements and respects current regulations.

### Characteristics of the support

The substrate on which the product will be installed must have the characteristics detailed below. The assurance and the verification of these characteristics is the responsibility of the individual who designs and completes the project.

#### IMPORTANT

The Kerlite Easy system is a decoupled system, therefore it can also be used on supports that are not perfectly COMPACT (in terms of surface and thickness) or INTACT.

#### CLEAN

The surface of the support must be clean and free of impurities (for example cement slurry, penetrating oils, or traces/residue of paints, adhesives, etc.). In the event that these are present, it is necessary to remove them with the appropriate products and methods.

#### STABLE AND DRY

The support must be stable and superficially dry. If the instructions of the producer of the screed are respected and if the rules of good building practice have been followed, then it is not necessary to test for residual moisture. If you wish to conduct the tests anyway, then you must remember that the mass of the residual moisture is determined through a measurement taken with a carbide hygrometer. Throughout the thickness of the substrate and for all measurements made, at least one for each room, the maximum percentage allowed must be:

- 3% for CT class screeds (cement based and special binding agents);
- 0.5% (0.3% in the case of substrates with radiant heating and cooling) for class CA screeds (based on calcium sulphate / anhydrite).

#### WARPAGE

Flatness of the support is checked by using a levelling rod with a length of at least 2 metres. Place the rod on the substrate in all directions. The permissible tolerance is 2 mm. If the surface does not meet the specified requirements, a levelling layer is required.

## Analysis of the substrate: what to do if it is not flat?

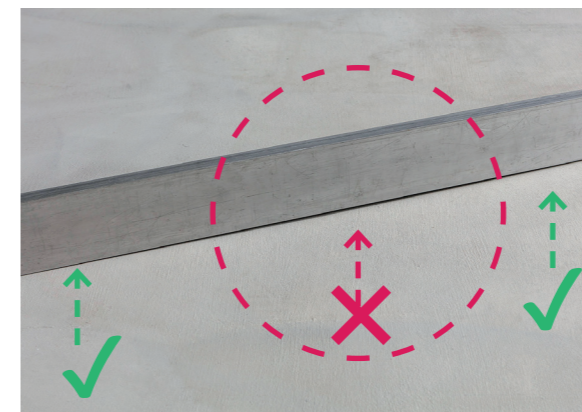
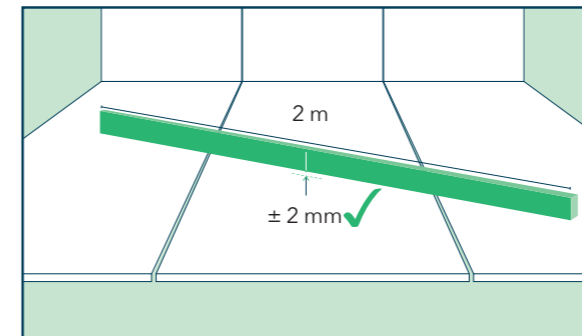

If the substrate is not flat as indicated previously one must use adequate surface levelling products. Apart from the standard "wet" levelling solutions, with Kerlite Easy one can also use "dry" levelling solutions. This second method is only possible with Kerlite Easy.

### Dry levelling system

The dry levelling system consists in laying compact plastic sheets to compensate for any differences in the surface level. The sheets especially in the A4 size and with a thickness of 0.15 mm are easily found in stationaries.

#### BEFORE INSTALLATION

If while checking the substrate issues are found in the flatness of the surface, they can be corrected by spreading where necessary the plastic sheets so as to obtain a flat substrate. Once the substrate is flat proceed with the laying of the mat.

#### DURING AND AFTER INSTALLATION

The "dry" levelling system is simple and it is also possible to correct issues regarding the flatness of the surface even AFTER Kerlite has been laid.

- 1) Remove the Kerlite Slab.
- 2) With a levelling rod or even simply a portion of a Kerlite slab one can check for flatness.
- 3) Add the plastic sheets so as to compensate and flatten out the surface.
- 4) Lay back the Kerlite slab.

## Planning the Work: the Required Tools

---

**For installation of the system, the following tools are required:**

- 1) Manual tile cutter / tools for working with Kerlite
- 2) Cutter
- 3) Pencil
- 4) A ream of plastic sheets, size A4, preferably with a thickness of 0.15 mm, for correcting any potential unevenness in the support
- 5) 2 mm spacers
- 6) Spray bottle with a mixture of water and dish soap (ratio 10 to 1) / pre-packaged product such as "FILA Silicone Refiner", "Mapei UltraCare Smooth Silicone" and "ARDEX SG lubrificante"
- 7) Gun for applying the silicone. For larger projects, it is recommended the use of battery-powered guns for silicone

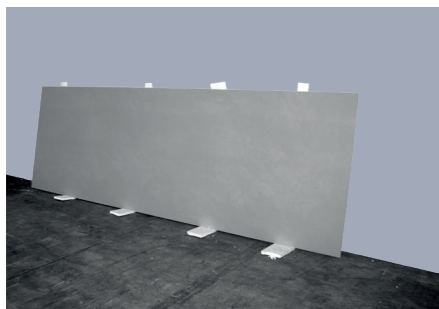

## Handling and Storage of the Materials

**K'ERLITE**  
 COTTOD'ESTE

For manual handling, package handling, and storage of Kerlite, please refer to the Kerlite Technical Manual.

## SILENT

soundproofing mat



SILENT does not require specific precautions, but must be stored away from atmospheric agents. The individual rolls can be stored either vertically or horizontally and must not be stacked one on top of the other. When there are 40 rolls, these are packed into boxes and put on standard 80x120 pallets. No more than two boxes can be stacked on top of one another. Each box contains 40 rolls for a total of 400 sqm of matting and a total of 600 kg (plus the weight of the box and the pallet).

## FILLER

finishing sealant

### FILLER FAST



Easy and quick to apply for a pedestrian floor in just a few hours. Its matte finish makes it perfect for modern surfaces.

### FILLER ARDEX SC MATT



Easy and quick to apply for a pedestrian floor in just a few hours. The remarkable textured look makes it ideal for high-end surfaces.

## Control of materials

### Checking the materials

The installer must check the materials before using them and must formally inform the client of any obvious defects promptly. Defective materials must not be installed unless a formal written order has been received from the customer.

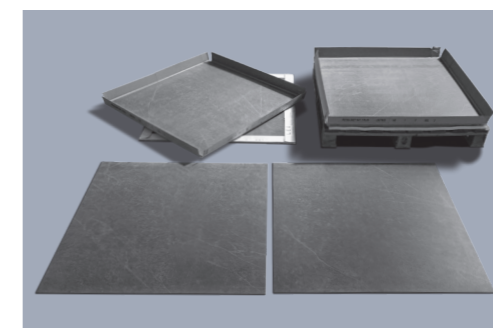
**K'ERLITE**  
 COTTOD'ESTE

## SILENT

soundproofing mat



## FILLER

finishing sealant



# Laying of the Mat, Installing and Cutting Kerlite

Once these steps have been completed, you may proceed with the laying of the SILENT mat.

## Laying of SILENT Mat



Lay the mat starting from the corner of the space.

Cut to size.

## Position the Kerlite Slabs

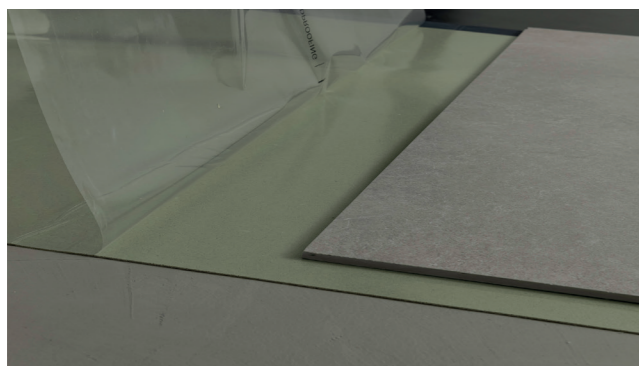

DO NOT remove completely the protective film. The film must be removed gradually while the Kerlite slabs are being laid.

Lay the Kerlite slabs, using spacers to distance them from each other. The spacers will not be removed, but rather covered by the grout so be sure to push them down as far as possible.



Cut to size. Around the perimeter of the room, maintain a distance from the walls of approximately 5 mm. This outer joint will then be covered by the skirting or can be filled with silicone like a normal grout line.

**KERLITE EASY MUST BE LAID EXCLUSIVELY WITH A CONTINUOUS GROUT LINE, WITH THE EXCEPTION OF THE 20x180 CM, 30x240 CM, AND 33x300 CM SLABS, WHICH CAN BE LAID WITH A STAGGERED GROUT LINE.**

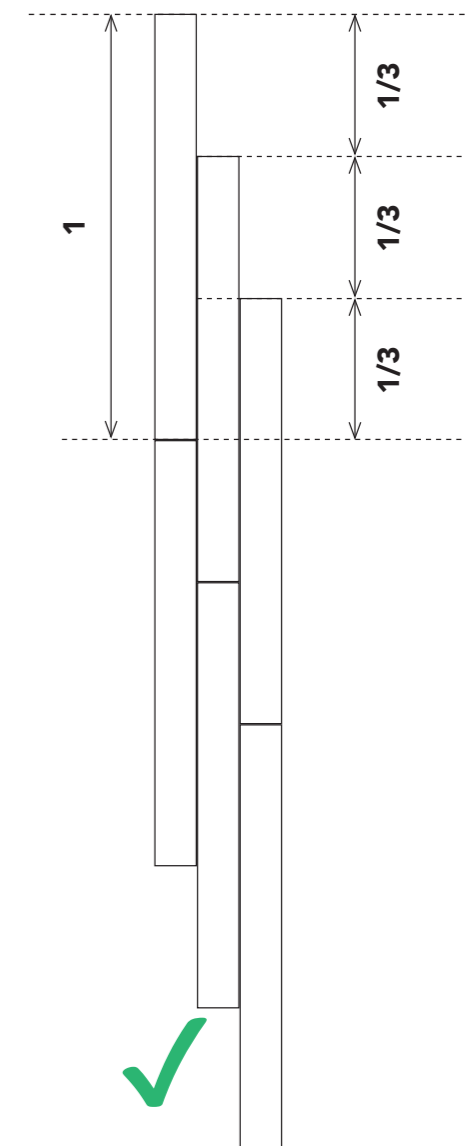
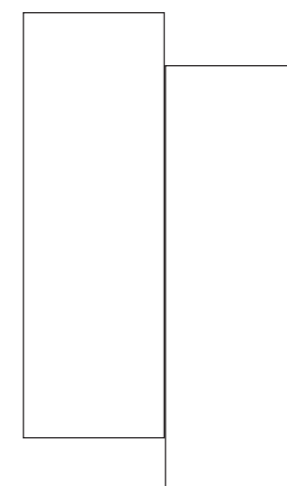
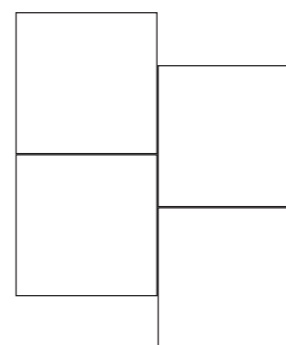
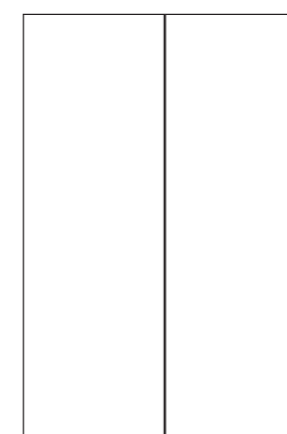
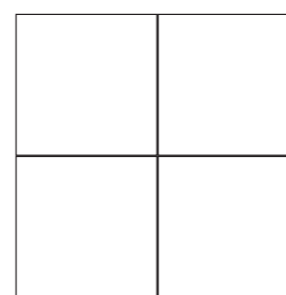

## Cutting Kerlite Slabs

For information regarding the cutting of the slabs refer to the instructions in the Kerlite Technical Manual. It is important to note that L-shaped slabs and slabs with holes drilled through cannot be used with Kerlite Easy.

# Grouting

## FILLER finishing sealant

### Grout Lines and Expansion Joints

#### GROUT LINES

So-called "zero grout line" installation is not recommended. The minimum size of the grout lines is 2 mm. The grouting and cleaning of the surface of laminated porcelain stoneware from residues of installation materials must be carried out in parallel and always following the instructions of the grout manufacturer, so that, at the end of grouting, the tiling is finished and clean.

#### INTERMEDIATE, EXPANSION AND PERIMETER JOINTS

The use of KERLITE EASY does NOT require structural and expansion joints. Meanwhile, outer joints, in correspondence with fixed elements in the bearing structure, must be placed along the perimeter of the tiling and must measure approximately 5-8 mm. This outer joint can be covered with skirting or filled with silicone like a normal grout line.



The use of 2 mm spacers, which can be easily purchased, makes it possible and very simple to create uniform grout lines. The spacers will not be removed, but will rather be covered by the grout, so be sure to push them far enough down.

### Grouting

FILLER is an acetic silicone that comes in cartridges, created to fill the grout lines of the KERLITE EASY system. FILLER serves two functions:  
1) It makes the floor waterproof by sealing the Kerlite slabs;  
2) It serves as an expansion joint thanks to its elasticity.



- 1 In order to apply the silicone, in cartridges, a silicone gun is required. The fluidity of the silicone makes it appropriate for use with either a manual silicone gun, more common and less expensive, or an electric gun, which is certainly more convenient when filling the grout lines of a large floor.

FILLER comes in 310 ml cartridges. To use cut the cartridge at the top of its thread. For grout lines of 2 mm, it is not necessary to cut the cartridge at the top of its thread; just screw on the nozzle, insert the cartridge in the gun, and extrude.

## FILLER

finishing sealant

## Grouting

## REMOVING EXCESS SILICONE

The removal of the silicone MUST be done within 10 minutes of application so as to avoid hardening of the superficial part.

To remove partially reticulated FILLER from tools and surfaces, you can use common solvents (ethyl acetate, petrol, toluene). After it is fully reticulated, the silicone can only be removed mechanically.

When exposed to air, FILLER reticulates and becomes elastic due to the effect of the moisture in the air. The speed of its reticulation depends very little on temperature and is, instead, primarily dependent on the atmospheric moisture present. The reticulation process at +23°C and 50% atmospheric moisture will take 10-12 hours to fully harden.

## NECESSARY TOOLS

Two tools are necessary for removing excess silicone:

- 1) Spray bottle with a mixture of water and dish soap (ratio 10 to 1) / pre-packaged product such as "FILA Silicone Refiner", "Mapei UltraCare Smooth Silicone" and "ARDEX SG lubrificante".
- 2) An empty cartridge of silicone used for the grouting. Remember to remove any residual silicone from the empty cartridge that may ooze out of the nozzle so as to avoid having this potentially drip onto the floor.

**NOTE:** with grout lines of 2 mm, a cartridge will be used up after approximately 8 linear meters, therefore within the 10 minute time limit for cleaning the excess silicone.



2

Using the spray bottle, thoroughly spray the part of the grout line that is to be cleaned. Spray the rear extremity of the cartridge which will be used to pick up the excess silicone. Rest the cartridge against the grout line and scrape up the excess silicone. The excess silicone will remain inside the cartridge. Continue in this manner for the entire cleaning of the grouted area.

**IMPORTANT:**

Before wiping up the excess silicone, spray the soap and water solution onto the floor area and onto the nozzle of the empty cartridge each time. If small crests or imperfections appear in the remaining silicone, spray some of the solution onto that area and onto your fingers.

Then trace over the grout line with a finger. Also in this case, remember to first spray the soap and water solution.

**LIGHT FOOT TRAFFIC AND READY TO USE**

The EASY system with FILLER FAST grout is set for light foot traffic after approximately 24 hours and is ready for use after approximately 7 days (calculated on the basis of +23°C and 50% atmospheric moisture).

**WHEN THE SILICONE IS DRY, THOROUGHLY WASH THE FLOOR**

Thoroughly wash and dry the floor.

The removal of the excess silicone leaves behind a significant amount of soap and water, which may look like streaks along the grout lines. A thorough washing will make the floor look perfect. Do not walk on the silicone before it is completely dry (approximately 12-18 hours, depending on the climatic conditions).



**THANKS TO KERLITE EASY  
IT IS NOT NECESSARY TO CREATE  
STRUCTURAL OR EXPANSION JOINTS.**

# Cleaning and Protection

---

## Post-installation cleaning

The installer must also provide clean tiling for any acceptance tests.

The "post installation" cleaning serves to remove residual grout and is absolutely mandatory upon completion of the project.

Non-slip surfaces: due to their particular, non-slip, rough or structured textures, are more difficult to clean.

Therefore, we recommend paying particular attention to cleaning methods, specifically by intervening rapidly.

## Protection

It is the installer's responsibility to protect the finished, clean tiling.

The protection of the ceramic covering for the period between the end of the installation and delivery to the client is all the more important when the environment in question will be subjected to significant foot traffic from other building operators (painters, electricians, bricklayers, etc..).

The protection of the slabs is carried out by applying suitable protective materials.

To avoid the formation of condensation which would cause problems with FILLER's reticulation, do not cover the freshly grouted surface with sheets or other materials.

For **FILLER** wait at least 10-12 hours depending on the temperature before protecting the surface.



**IMPORTANT**

The information and suggestions given in this manual are to be considered valid until the publication of a new one most recent update.

The new update cancels all of the above.

You can check for new ones updates on the website or by contacting the technical service company.

The company reserves the right to make, if deemed it appropriate, technical and formal changes to what illustrated in this publication.

**2023 EDITION**

**CERTIFICATIONS**



Cotto d'Este guarantees for 10 years the resistance to wear of Kerlite ceramic slabs, the integrity of the Silent matting, and the functional characteristics of the Filler sealant, if installed in interior environments for residential or light commercial use.



Discover more:  
[cottodeste.it](http://cottodeste.it)





Via Emilia Romagna, 31 - 41049 Sassuolo (Modena) Italy  
Tel +39 0536 814911 - Fax +39 0536 814921  
cottodeste.it - blustyle.it

PANARIAGROUP INDUSTRIE CERAMICHE S.p.A.

Follow us on:

